



VATECH ASSURANCE

VATECH IMAGING SYSTEMS

vatech

VATECH IMAGING SYSTEMS

About Vatech America	3
Vatech Assurance	4
PaX-i	5
PaX-i Plus	8
A9	11
Smart Plus	14
Green CT 2	18
Green X 12	21
Green X	24
Green X Plus	27
Green X 21	30
Clever One	34
Ez3D-i	36
EzDent-i	38
EzRay Air Wall	39
EzRay Air Portable	42
HD Sensor	45
EzCam	47

World's Premier Dental Imaging Company

Vatech is a leading manufacturer of radiographic imaging solutions for the medical, dental, and veterinary fields with offices in over 70 countries worldwide.



MISSION: *With honesty and integrity, we strive to be the industry leader and preferred partner by providing innovative imaging solutions and first class client services that ultimately enhance the quality of patient care.*



As the US subsidiary of Vatech, Inc. Vatech America is committed to providing the industry with innovative dental x-ray imaging solutions while maintaining a primary focus on ultimately enhancing the quality of patient care.

From the world's first 3-in-1 digital x-ray system to low radiation CBCT devices, Vatech America is the clinicians' preferred vendor for their diagnostic imaging endeavors.

A History of World Firsts

2005	2007	2008	2009	2013	2017	2020
Launched World's First 3-in-1 Digital X-ray System: Picasso-Trio	Launched World's First Auto-Switching System: PaX-Duo3D	World's First One Shot Cephalometric: PaX-Uni3D	World's First Free FOV System: PaX-Reve3D	Groundbreaking Low Radiation System: Green CT	41-Layer Digital Panoramic Radiograph: PaX-i Insight	World's First Dental Application of Carbon Nano Technology: EzRay Air P



VATECH ASSURANCE

What is Vatech Assurance?

Vatech Assurance, a core value of Value Added Technologies, is our promise to our customers that we will not only provide a premium dental imaging system to suit your needs, but also to ensure the value of your investment from becoming obsolete by providing multiple options for upgrading to the newest technologies as they are developed. Whether it's a defined transition strategy to newer technologies, or protection of currently owned technology, Vatech Assurance provides industry leading service, support, warranty coverage, as well as added value that reaches beyond the x-ray itself.

No Asterisks | No Legalese | Just Vatech Assurance



BUYBACK PROGRAM

What is the Vatech Buyback Program?

Within five years of the installation date, Vatech and your supporting dealer will buyback your 2D imaging system, applying 100% of the original purchase price you paid towards an eligible brand new 3D imaging system. Rather than upgrading the hardware of an aging imaging system, Vatech will provide a BRAND NEW 3D imaging system if you choose to exercise this policy. 0% Depreciation!

Maintain your upgradability by resetting your technology with a BRAND NEW device with the Vatech Buyback Program.



TRADE IN/UP PROGRAM

What is the Vatech Trade in/Trade up Program?

As technology rapidly evolves, protecting your investment from accelerated depreciation can be found exclusively in the Vatech Trade in/Trade up Program.

Vatech will provide a trade in value for your 3D imaging system, utilizing a *lower-than-market depreciation rate* allowing you to maximize the return for your imaging system when it's time to upgrade to a new 3D device.

Minimize your long term costs, maximize the residual value of your imaging system, and upgrade to newer and more advanced technology with ease by participating in the Vatech Trade in/Trade up Program.

Partnership | Commitment | Peace of Mind | Vatech Assurance

YOUR PARTNER IN DIGITAL SUCCESS,

PaX-iTM



SUPERIOR IMAGE QUALITY

- Optimal image for accurate diagnosis

TWO DEDICATED SENSORS

- Specialized sensors for Pano & Ceph
- Streamlined workflow and prolonged lifespan of sensors

USER-FRIENDLY SOFTWARE, EZDENT-I

- Complete diagnostic and consultation solution

THE ADVANCED IMAGING SOLUTION FOR ACCURATE DENTAL DIAGNOSIS

The PaX-i provides the most precise and high quality panoramic images by combining image processing and accumulated experience in dental imaging from Vatech. This will increase your diagnostic accuracy for improved treatment planning and patient satisfaction.



MAKE YOUR DIAGNOSIS EASY AND EFFICIENT WITH VARIOUS CAPTURE MODES

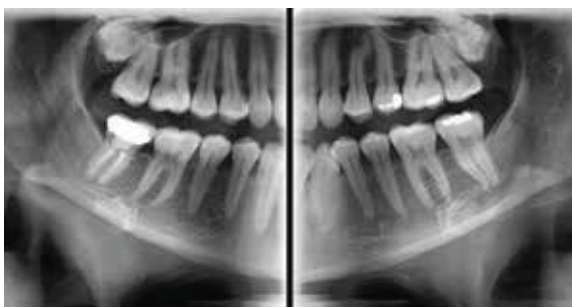

Bitewing Mode



TMJ Mode

SELECTION	ARCH	EXAMINATION MODE
PANO EXAMINATION	Narrow / Normal Wide / Child	Standard / Right / Front / Left
	Orthogonal	Orthogonal Standard / Right / Front / Left Bitewing Standard / Right / Front / Left
SPECIAL EXAMINATION	Normal	TMJ LAT Open / Close TMJ PA Open / Close Sinus LAT / PA

PRODUCT CONFIGURATION

	PANO	CEPH	
		SCAN	RAPID
PaX-i	•	–	–
PaX-i SC	•	•	–

SPECIFICATIONS (PaX-i : PCH-2500)

Function	Pano + Ceph		
Scan Time	Pano : HD 13.5 sec / Normal 10.1 sec Ceph : Scan 12.9 sec		
Focal Spot	0.5 mm		
Tube Voltage/ Current	50-90 kVp / 4-10 mA		
Ceph FOV Size	SC	8.3"x9.1" [LAT, PA, SMV, Waters View, Carpus] 10.6"x9.1" [Full LAT]	
Gray Scale	14 bit		
Patient Positioning	Standing / Wheelchair Accessible		

DIMENSIONS [Unit: Inch]

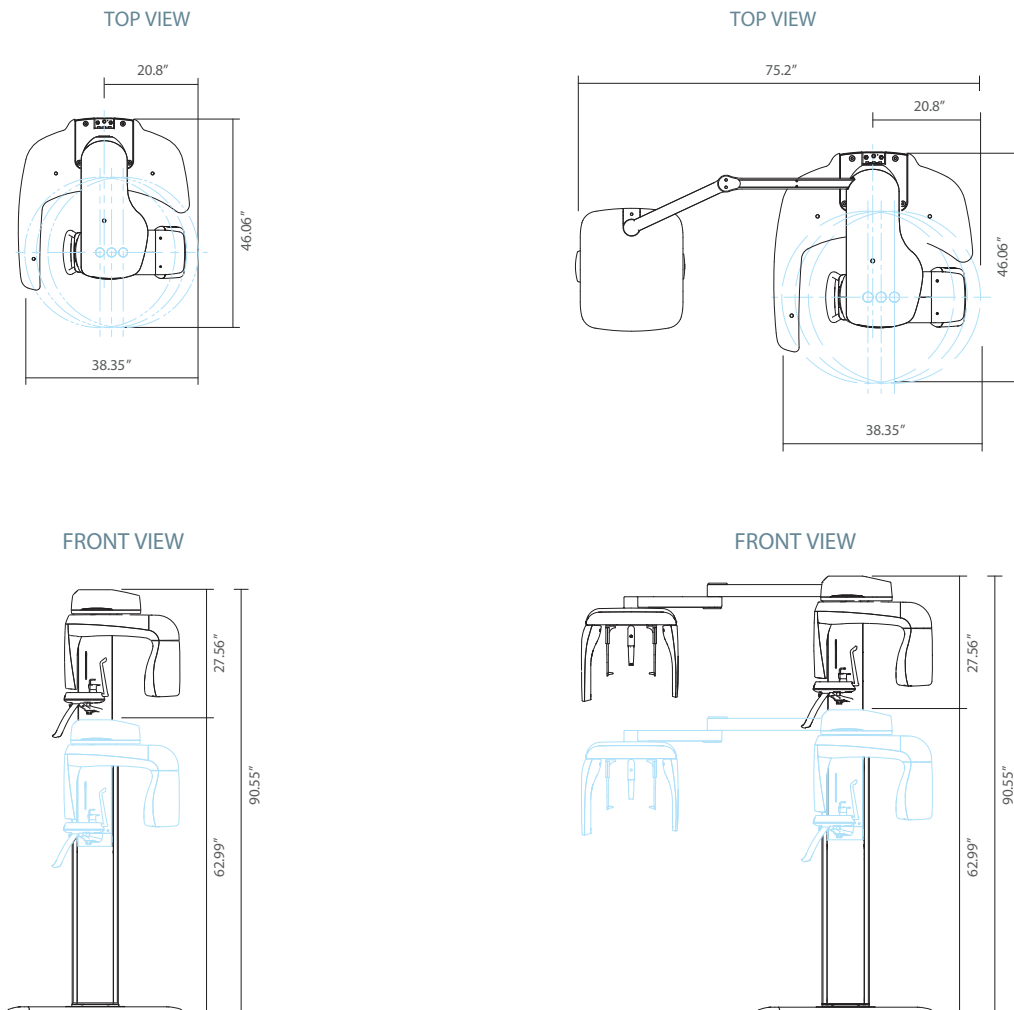

PaX-i Plus™



RAPID CEPH

- 1.9 second acquisition time produces superb image quality
- Reduced motion artifacts and faster workflow

USER FRIENDLY EZDENT-I SOFTWARE

- Complete solution for consultation
- Easy to learn, easy to use

THE ADVANCED IMAGING SOLUTION FOR ACCURATE DENTAL DIAGNOSIS

The PaX-i Plus provides the most precise and high quality panoramic images by combining image processing and accumulated experience in dental imaging from Vatech. This will increase your diagnostic accuracy for improved treatment planning and patient satisfaction.



MAKE YOUR DIAGNOSIS EASY AND EFFICIENT WITH VARIOUS CAPTURE MODES

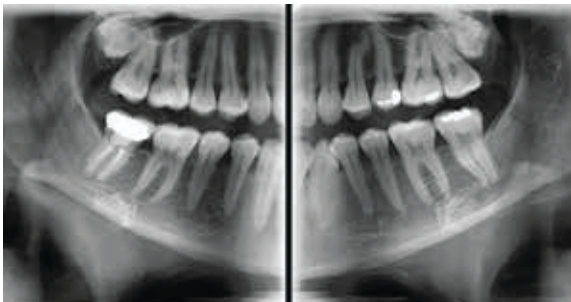

Bitewing Mode



TMJ Mode

SELECTION	ARCH	EXAMINATION MODE
PANO EXAMINATION	Narrow / Normal Wide / Child	Standard / Right / Front / Left
	Orthogonal	Orthogonal Standard / Right / Front / Left Bitewing Standard / Right / Front / Left
SPECIAL EXAMINATION	Normal	TMJ LAT Open / Close TMJ PA Open / Close Sinus LAT / PA

MINIMIZE MOTION ARTIFACTS WITH RAPID CEPH TECHNOLOGY

The next step in cephalometric technology, Vatech's new Rapid Ceph minimizes motion artifacts and enables faster diagnostic workflow while providing the highest quality digital images.

GREAT CLINICAL CARE WITH RAPID CEPH TECHNOLOGY



**1.9
sec**

PRODUCT CONFIGURATION

	PANO	CEPH
PaX-i Plus RC	•	•

SPECIFICATIONS (PaX-i Plus : PCH-30CS)

Function		Pano + Ceph		Weight	With Ceph unit	264.5 lbs. – without Base
Focal Spot		0.5 mm (IEC60336)				352.7 lbs. – with Base
Scan Time	Pano	Normal	10.4 sec	Dimensions	With Ceph unit	75.98 in (L) x 47.24 in (W) x 90.55 in (H)
		HD	14 sec			
	Ceph	1.9 / 3.9 sec				
Gray Scale		14 bit				
Tube Voltage / Current		60 ~ 99 kV / 4 ~ 10 mA				

* The specifications are subject to change without prior notice.

DIMENSIONS [Unit: Inch]

TOP VIEW

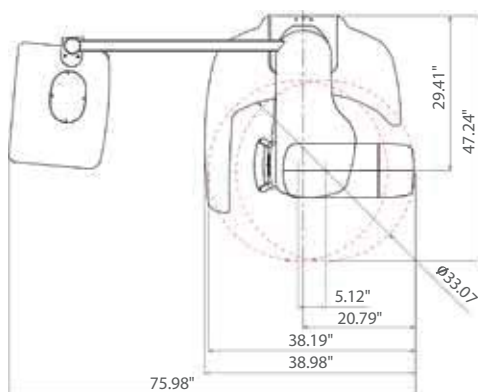

FRONT VIEW

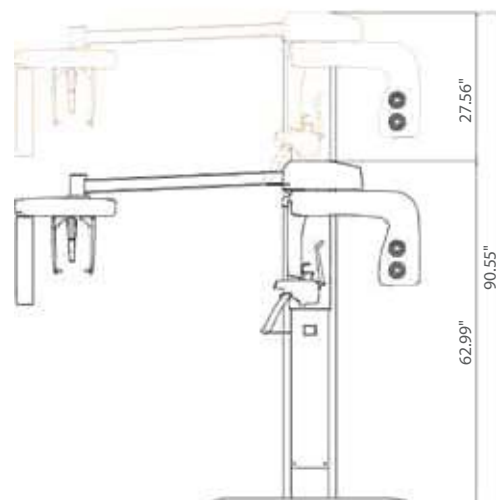

THE START OF YOUR CBCT JOURNEY

vatech A9™



- EMERGING AI TECHNOLOGY
FEATURING MAGIC PAN
- LIMITED FOV 8X8
- MINIMIZE MOTION ARTIFACTS WITH
RAPID CEPH TECHNOLOGY
- EASE OF USE - NO CANINE,
NO TEMPLE SUPPORTS

EMERGING AI TECHNOLOGY FEATURING MAGIC PAN

MAGIC PAN utilizes hundreds of layers of panoramic images during acquisition. Vatech Artificial Intelligence examines all layers, reconstructs, and provides the optimal image.



LIMITED FOV 8X8

8x8 images enable fundamental diagnoses and treatment planning, including both the maxillary and mandibular areas, in a single scan. It is useful for implant surgeries and diagnoses.

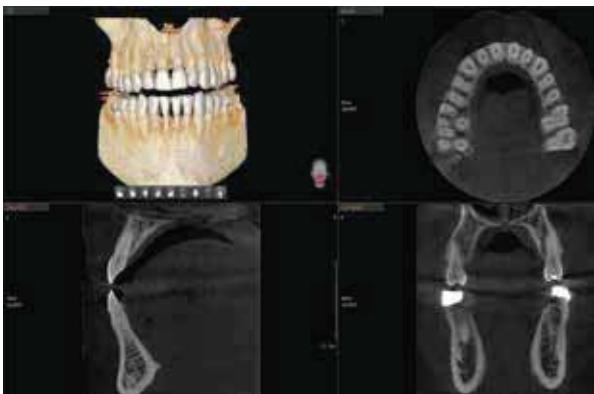

MINIMIZE MOTION ARTIFACTS WITH RAPID CEPH TECHNOLOGY

The next step in cephalometric technology, Vatech's new Rapid Ceph minimizes motion artifacts and enables faster diagnostic workflow while providing the highest quality digital images.



PRODUCT CONFIGURATION

	CBCT	PANO	CEPH
Vatech A9	•	•	-
Vatech A9 RC	•	•	•

SPECIFICATIONS (vatech A9: **PHT-30CSS**)

Function		CT + Pano + Ceph
Focal Spot		0.5 mm (IEC 60336)
CT FOV Size		8x8 cm
Voxel Size		0.2 mm / 0.3 mm
Scan Time	CT	18 sec
	Pano	11.9 sec / 14.1 sec
Gray Scale		14 bit
Tube Voltage		60 ~ 99 kV
Current		4 ~ 10 mA
Weight	Without ceph unit	238.76 lbs. (Without Base)
		353.84 lbs. (With Base)
	With ceph unit	296.08 lbs. (Without Base)
		411.16 lbs. (With Base)

*The specifications are subject to change without prior notice.

DIMENSIONS (Unit: Inch)

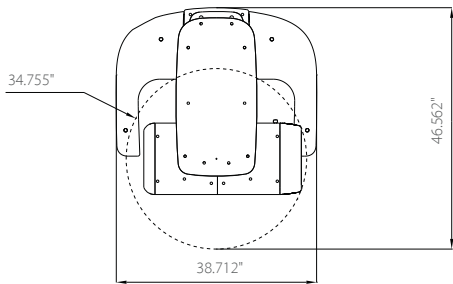

Top View

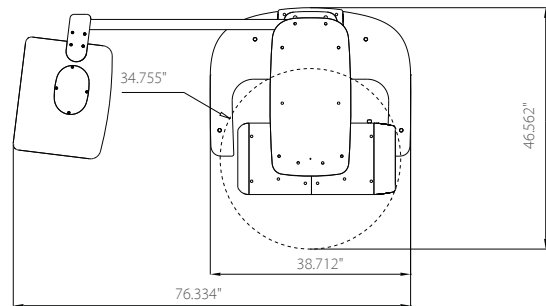

Front View

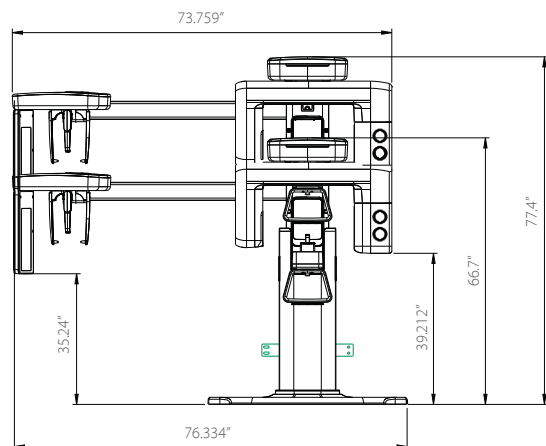
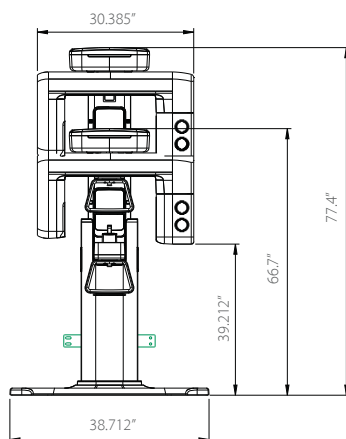

***An additional 3 inches (76.2 mm) of space is required behind the unit for wall mount bracket installation (mandatory unless there is a base mount installation).**

No More than what you *want*,
No Less than what you *need*.

Smart PlusTM



-  **ONE SCAN, TWO IMAGES**
-  **EXTENDED ARCH-SHAPED FOV**
-  **INNOVATIVE COMPRESSED SENSING TECHNOLOGY**
-  **3D SCANNING FOR MODEL**

SMART INNOVATION

ONE SCAN, TWO IMAGES

One scan with the Smart Plus gives you a CT image and Auto Pano image. This means that patients who require both images do not need to undergo two x-ray scans. The CT and Auto Pano images are displayed within One Viewer as well.

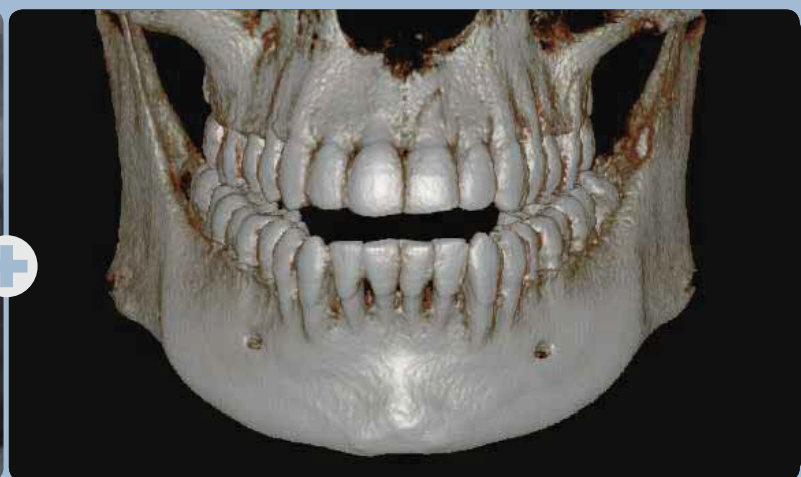

* Conventional panorama mode is provided.



[2D AND 3D IN ONE VIEWER]

There are many benefits to viewing 2D and 3D images simultaneously.

There is no need to utilize two different software programs and the One Viewer feature presents a professional look for your patients. This layout will help your patients better understand their images and will eventually lead to increased acceptance rates.

EXTENDED ARCH-SHAPED FOV

The innovative FOV of the Smart Plus provides an arch-shaped volume, showing a wider view of dentition when compared to other devices with the same FOV. When the tooth is lying on its side, there is a high possibility that the tooth will be cut out of the image. This possibility is eliminated with our "arch-shaped volume" and shows the hidden dentition area.

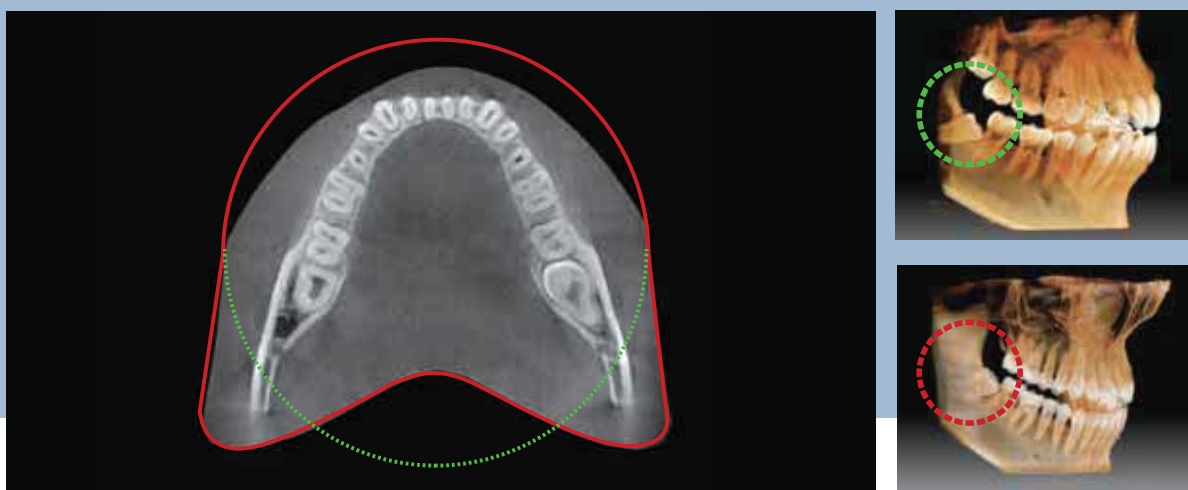

INNOVATIVE COMPRESSED SENSING TECHNOLOGY

Our innovative image reconstruction technology has dramatically improved the quality of our 3D scans.

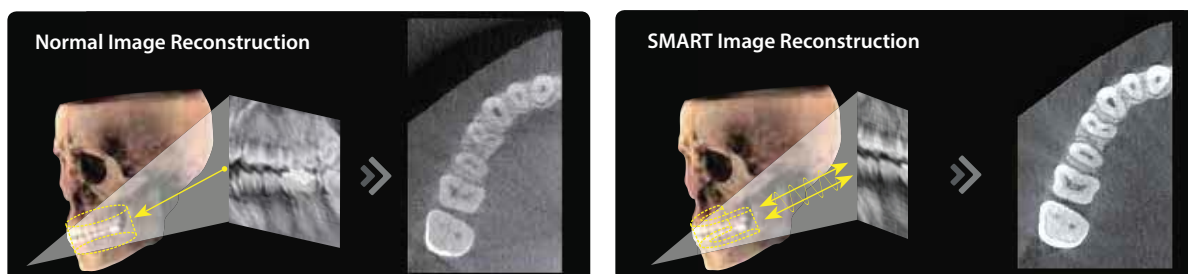

3D SCANNING FOR MODEL

3D model scan enables users to store plasters as digital models. The specially designed Jig offers stable protection from partial model to full model.



*3D scanning for Plaster Cast with FOV 10x8.5 (cm)

PRODUCT CONFIGURATION

	CBCT	PANO	CEPH
Smart Plus	•	•	-
Smart Plus RC	•	•	•

SPECIFICATIONS (Smart Plus : **PHT-35LHS**)

Function	CT (with Auto Pano) + Pano + Ceph + Model Scan		
Focal Spot	0.5 mm (IEC 60336)		
CT FOV Size	5x5 cm / 10x8.5 cm (Anatomical 12x9 cm)		
Voxel Size	0.08 mm / 0.12 mm / 0.2 mm / 0.3 mm		
Scan Time	CT	18 sec	
	Pano	14.1 sec / 7 sec	
	Ceph	1.9 sec / 3.9 sec	
	3D Model	18 sec	
Gray Scale	14 bit		
Tube Voltage	60 ~ 99 kV		
Current	4 ~ 16 mA		
Weight	Without Ceph unit	302 lbs - without Base	
		418.9 lbs - with Base	
	With Ceph unit	357.1 lbs - without Base	
		474 lbs - with Base	

*The specifications are subject to change without prior notice.

DIMENSIONS (Unit: inch)

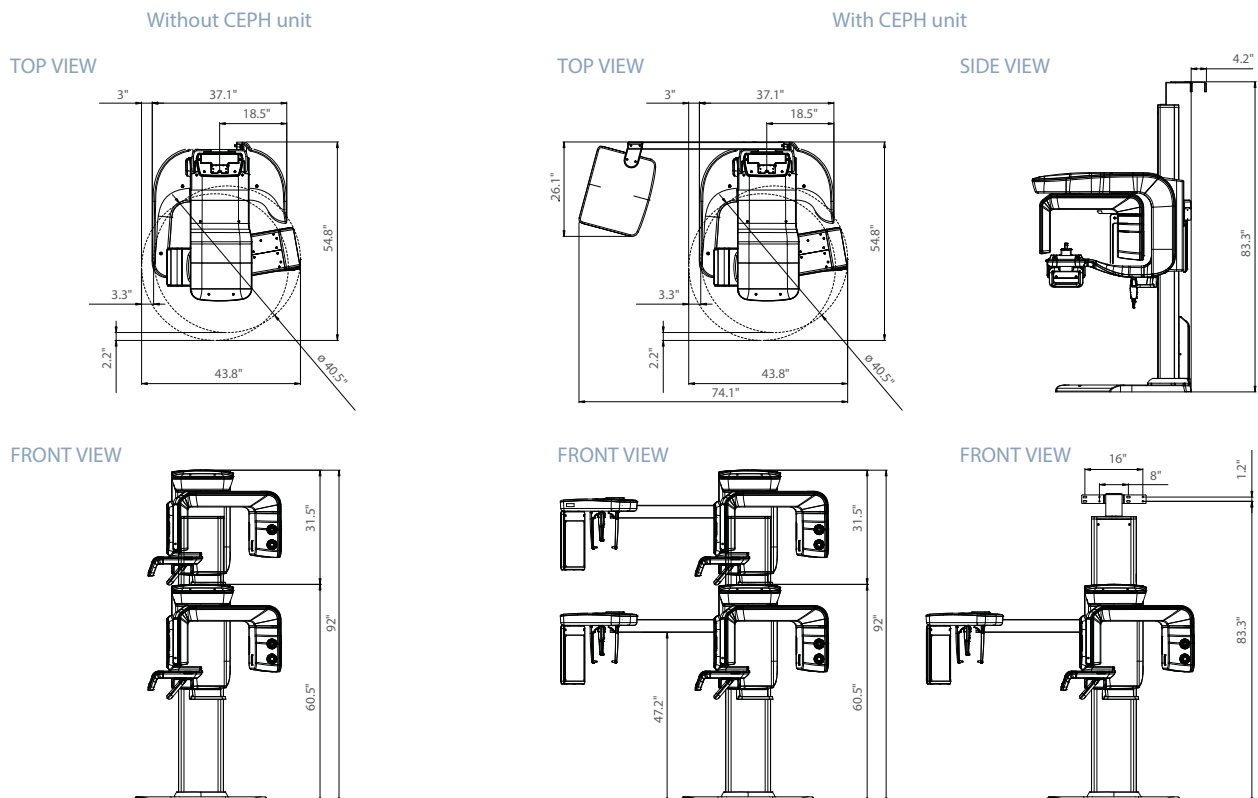

***An additional 3 inches (76.2 mm) of space is required behind the unit for wall mount bracket installation (mandatory unless there is a base mount installation).**

THE NEXT GREEN INNOVATION



- LOW DOSE AND HIGH IMAGE QUALITY
- GREEN SCAN TIME
- MULTI FOV SELECTION
- 3D SCANNING FOR MODEL



LOW DOSE AND HIGH IMAGE QUALITY

What has been developed at Vatech breaks many conventions in dental radiography. It was always believed that with low radiation comes inferior image quality, which renders it useless in clinical diagnosis. However, the Green CT 2 provides clinically diagnosable x-ray scans at a low x-ray dosage. With low dose radiography, achieving clinically diagnosable image quality is the new golden-standard.



Ceph



CBCT



Pano

Effective Dose Data

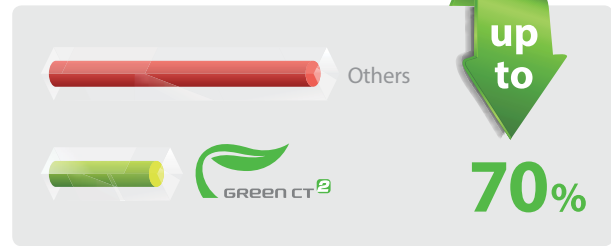





GREEN SCAN TIME

The Green CT 2 minimizes motion artifact and enables faster workflow due to its scan time. It produces superb diagnostic images, which will be a source of pride for any dental practice. Focusing on the highest quality of patient care, Vatech strives to improve the health and safety of your patients.



MULTI FOV SELECTION

The Green CT 2 offers a range of selectable fields of view. The Multi FOV enables the user to select the optimal FOV mode and minimizes exposure to areas not in the region of interest. Select the proper FOV size among 18x10, 16x9, 13x10, 12x9, 8x9, 8x5, and 5x5 based on a particular diagnostic need. It covers the full arch region, sinus, and left/right TMJ and it suits most oral surgery cases as well as multiple implant surgeries.

Endo & Single implant	Arch	Dual Arch	Sinus & TMJ
5x5	8x5 / 8x9	12x9 / 13x10	16x9 / 18x10
			
Optimal size to cover 3~4 teeth through capturing ROI	Basic FOV size & select a left or right or center arch	Suitable for multiple implant surgeries	Optimal size for sinus & TMJ diagnosis

*3D scanning for Plaster Cast with FOV 8x9 (cm)



3D SCANNING FOR MODEL

3D model scan enables users to store plasters as digital models. The specially designed Jig offers stable protection from partial model to full model.

SPECIFICATIONS [Green CT 2 : PHT-65LHS]

Function	CT + Pano + Ceph + Model Scan	
Focal Spot Size	0.5 mm (IEC60336)	
CT FOV Size	16x9 cm : Multi [5x5 / 8x5 / 8x9 / 12x9 / 16x9 cm] 18x10 cm : Multi [5x5 / 8x5 / 8x9 / 13x10 / 18x10 cm]	
Voxel Size	5 x 5	0.08 mm / 0.12 mm
	8 x 5	0.12 mm / 0.2 mm
	8 x 9	0.12 mm / 0.2 mm
	12 x 9	0.2 mm / 0.3 mm
	13 x 10	0.2 mm / 0.3 mm
	16 x 9	0.2 mm / 0.3 mm
	18 x 10	0.2 mm / 0.3 mm
Scan Time	Pano	14.1 sec / 7.0 sec
	Ceph	3.9 sec / 1.9 sec
	CBCT	9.0 sec (12x9 - 18x10) / 4.9 sec (5x5 - 8x9)
Gray Scale	14 Bit	
Tube Voltage / Current	60 - 99 kVp / 4 - 16 mA	
Weight	Without CEPH unit	295.4 lbs - without the Base
		412.3 lbs - with the Base
	With CEPH unit	350.5 lbs - without the Base
		467.4 lbs - with the Base
Dimensions	Without CEPH unit	44.29" (L) x 58.61" (W) x 91.95" (H)
	With CEPH unit	73.78" (L) x 58.61" (W) x 91.95" (H)

*The specifications are subject to change without prior notice.

DIMENSIONS [Unit: Inch]

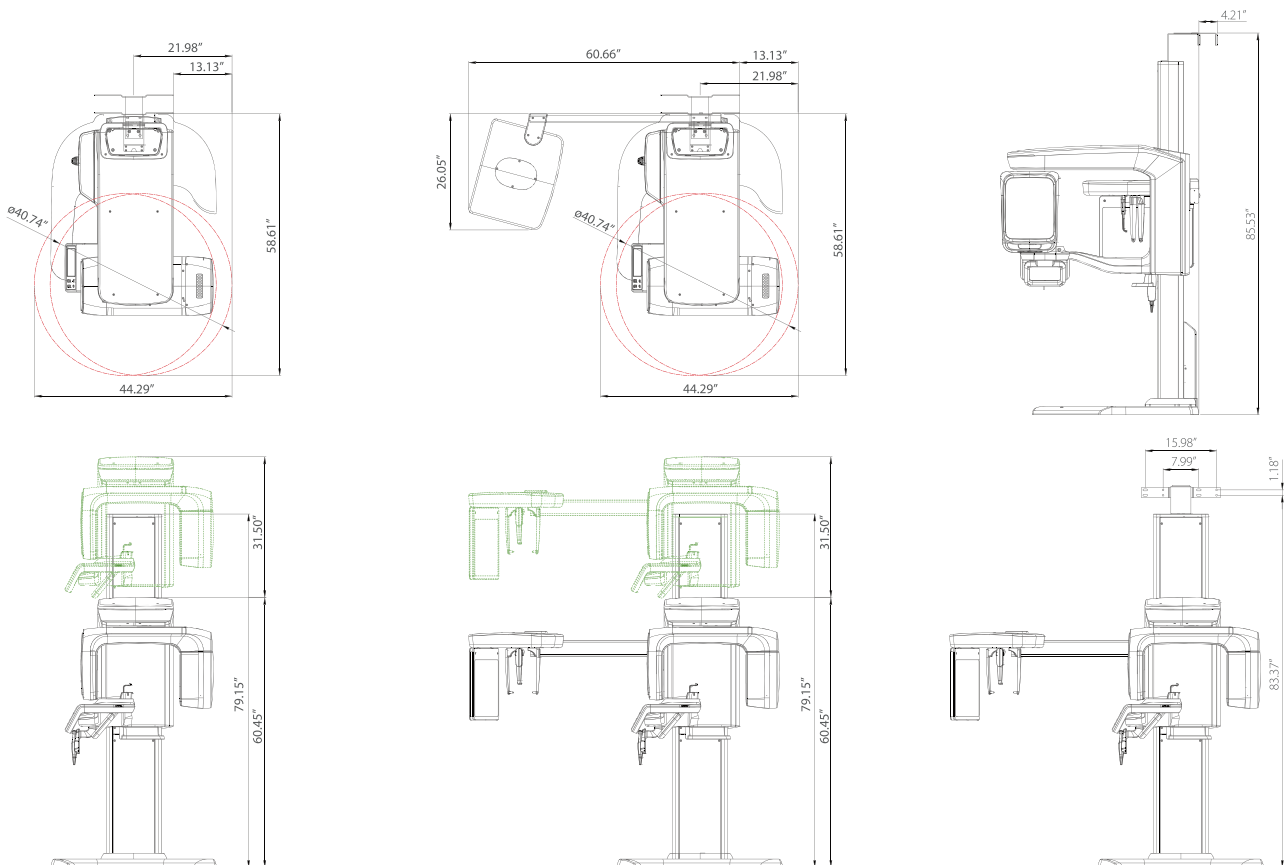

***An additional 3 inches (76.2 mm) of space is required behind the unit for wall mount bracket installation (mandatory unless there is a base mount installation).**

SPEED, QUALITY, PREDICTABILITY NO COMPROMISE

Green X 12™



- INNOVATIVE 3RD GENERATION COMPRESSED SENSING TECHNOLOGY
- HIGHEST RESOLUTION WITH 0.05 mm VOXEL SIZE
- ONE SCAN, TWO IMAGES
- 3D SCANNING FOR MODEL



INNOVATIVE 3RD GENERATION OF COMPRESSED SENSING TECHNOLOGY

Vatech dramatically improves its image quality with much less artifact and noise via its Compressed Sensing Technology (CST), iterating its reconstruction process 10 times more than the normal amount to depict the object's true representation.



ENDO MODE WITH HIGH RESOLUTION

With its 4cm x 4cm volume mode and 50 micron voxel size, the endo mode will optimize treatment of highly-focused regions of interest. It is ideal for endodontic use because the dentist is able to achieve an extraordinary image in a high-resolution voxel size.

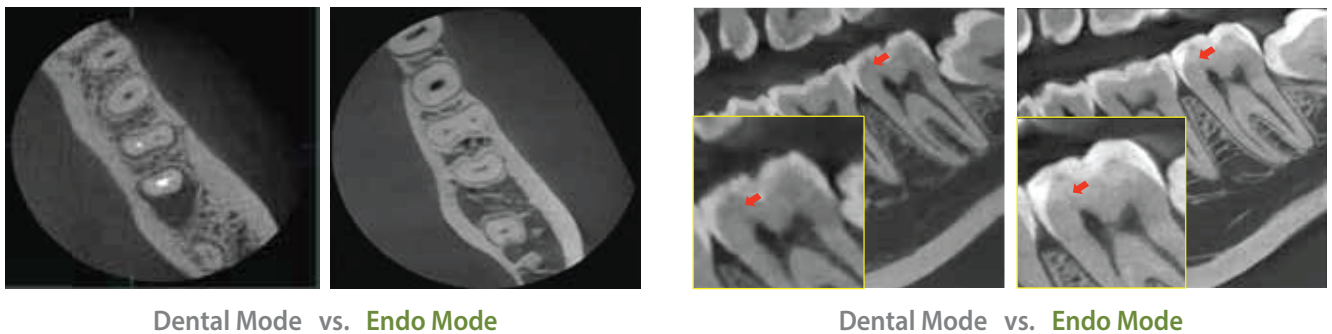

ONE SCAN, TWO IMAGES

One scan with the Green X 12 gives you a CT image and Auto Pano image. This means that patients who require both images do not need to undergo two x-ray scans. The CT and Auto Pano images are displayed within One Viewer as well.

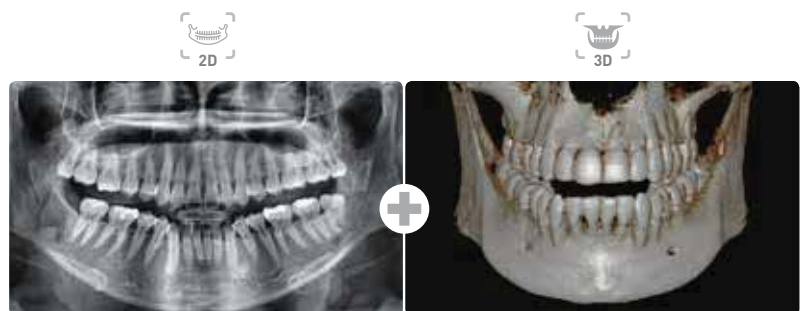

* Conventional panorama mode is provided.

3D SCANNING FOR MODEL

3D model scan enables users to store plasters as digital models. The specially designed Jig offers stable protection from partial model to full model.



*3D scanning for Plaster Cast with FOV 8x8 (cm)

SPECIFICATIONS [Green X 12 : PHT-75CHS]

Function	CT + Pano + Ceph + Model Scan	
Focal Spot Size	0.5 mm (IEC 60336)	
CT FOV Size	4x4, 8x5, 8x8, 12x8.5	
Voxel Size	4x4	0.05 mm
	8x5 / 8x8	0.12 mm / 0.2 mm
	12x8.5	0.2 mm / 0.3 mm
Scan Time	Pano	4.0 sec / 14.1 sec
	Ceph	1.9 sec / 4.9 sec
	CBCT	10.0 sec (8x5-8x8) 15.5 sec (12x8.5) 13.0 sec (4x4)
Gray Scale	14 Bit	
Tube Voltage / Current	60 - 99 kVp / 4-16 mA	
Weight	Without CEPH unit	359.13 lbs-without Base
		480.38 lbs-with Base
Weight	With CEPH unit	414.25 lbs-without Base
		535.50 lbs-with Base
Dimensions	With CEPH unit	75.02"(L) x 57.39"(W) x 91.24"(H) - without Base
		75.02"(L) x 57.39"(W) x 92.34"(H) - with Base
	Without CEPH unit	42.72"(L) x 57.39"(W) x 91.24"(H) - without Base
		42.72"(L) x 57.39"(W) x 92.34"(H) - with Base

*The specifications are subject to change without prior notice.

DIMENSIONS [Unit: Inch]

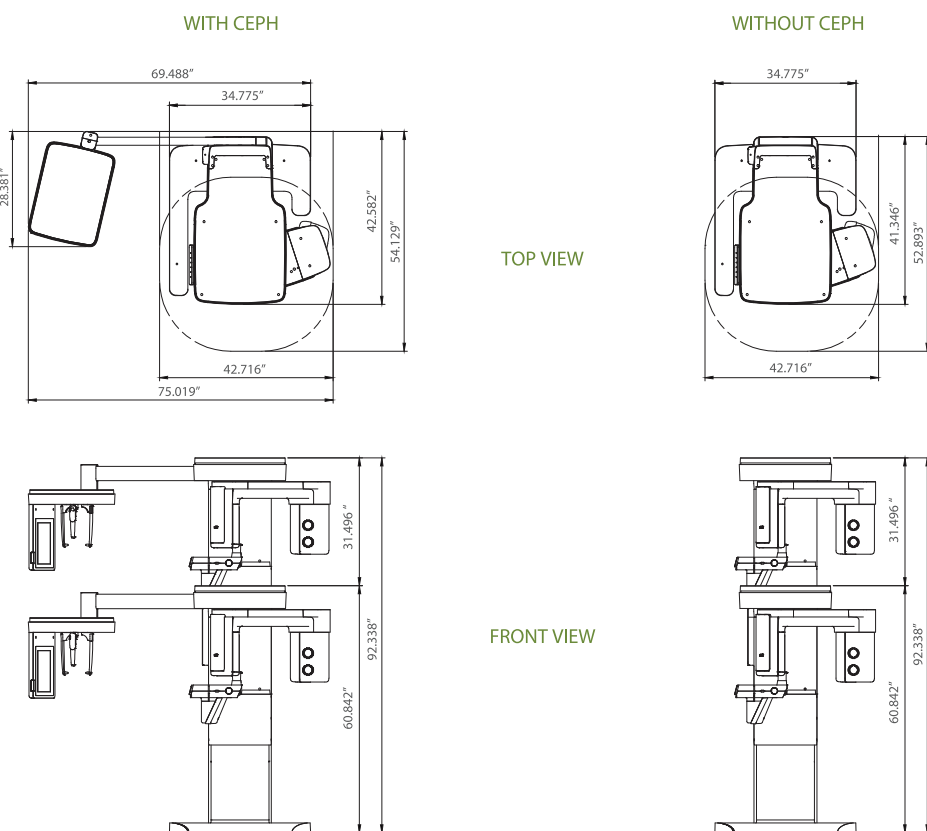

***An additional 3 inches (76.2 mm) of space is required behind the unit for wall mount bracket installation (mandatory unless there is a base mount installation).**

SPEED, QUALITY, PREDICTABILITY NO COMPROMISE

Green X™



- INNOVATIVE 3RD GENERATION COMPRESSED SENSING TECHNOLOGY
- HIGHEST RESOLUTION WITH 0.05 mm VOXEL SIZE
- LARGE SINGLE SCAN FOV
- FASTEST SCAN TIME
- GREEN LOW DOSE WITH HIGH QUALITY IMAGES

 GREEN CT

**49.5 μm**
CMOS
Sensor

INNOVATIVE 3RD GENERATION OF COMPRESSED SENSING TECHNOLOGY

Vatech dramatically improves its image quality with much less artifact and noise via its Compressed Sensing Technology (CST), iterating its reconstruction process 10 times more than the normal amount to depict the object's true representation.

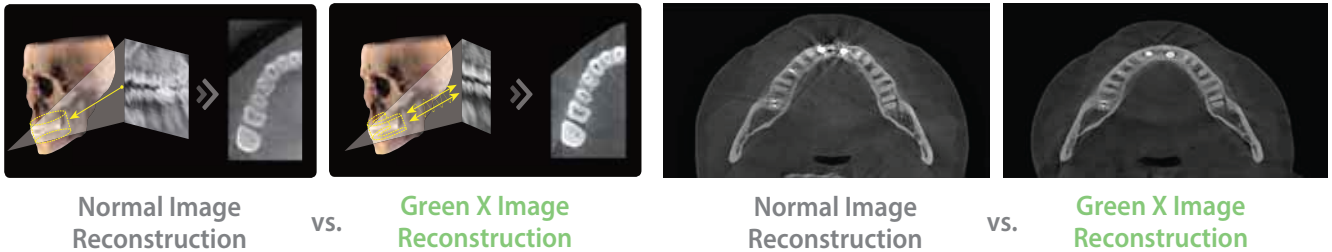

ENDO MODE WITH HIGH RESOLUTION

With its 4cm x 4cm volume mode and 50 micron voxel size, the endo mode will optimize treatment of highly-focused regions of interest. It is ideal for endodontic use because the dentist is able to achieve an extraordinary image in a high-resolution voxel size.

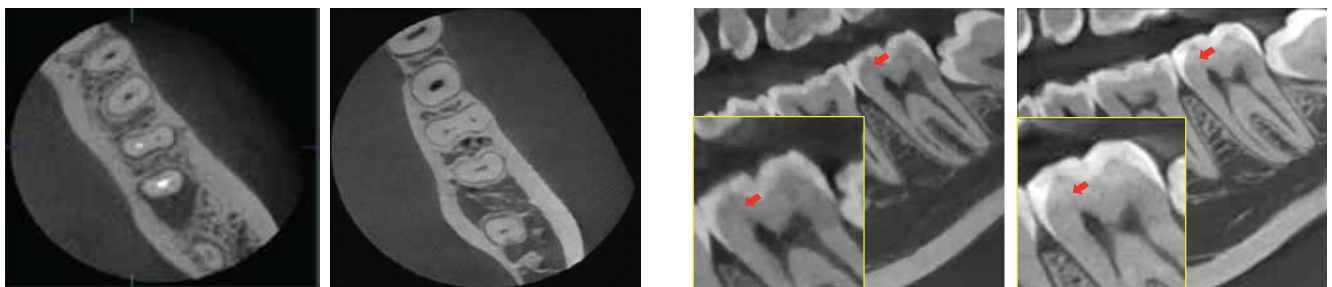

Dental Mode vs. Endo Mode

Dental Mode vs. Endo Mode

MULTI FOV SELECTION

The Green X offers a range of selectable fields of view. The Multi FOV option allows users to select the optimum FOV mode while minimizing exposure to areas that are not in the region of interest. The selection includes the following FOV sizes for diagnostic needs: 18x15, 16x11, 16x9, 12x9, 8x8, 8x5, 5x5 and 4x4. These options cover the full arch region, sinus and left/right TMJ, and suits most oral surgery cases and multiple implant surgeries.

	40mm	80mm	120mm	160mm	180mm
REGION	FOV 4x4/5x5 - Single tooth capture	FOV 8x5/8x8 - Central dentition - TMJ (R or L)	FOV 12x9 - Dual arch including sinus and nerve - TMJ (R or L)	FOV 16x9/16x11 - Back border of jaw (Ramus) - Dual arches back to the 3 rd molars plus sinus - Central incisor to spine	FOV 18x15 - Back border of jaw (Ramus) - Dual arches back to the 3 rd molars plus sinus - Central incisor to spine
CLINICAL IMPLICATION	- Implant single site - Endo - Perio - Complex impaction (3rd) - OMS - Supernumerary : Ortho	- Implantology - Guided Surgery - General Dentist - OMS - Orthodontics	- Surgical guides - Sinus lifts - Bone grafting - Bi lateral sinus augmentation	- Surgical Guides - Sinus lifts for both sinuses - Complex orthognathic cases - Simultaneous TMJ diagnosis (16x11)	- Surgical Guides - Sinus lifts for both sinuses - Complex orthognathic cases - Simultaneous diagnosis for both TMJs

GREEN SCAN TIME

Due to its scan time, the Green X minimizes motion artifact and enables faster workflow. It produces superb diagnostic images, which will be a source of pride for any dental practice. Focusing on the highest quality of patient care, Vatech strives to improve the health and safety of your patients.



SPECIFICATIONS [Green X 18 : PHT-75CHS]

Function	CT + Pano + Ceph + Model Scan	
Focal Spot Size	0.5 mm (IEC 60336)	
CT FOV Size	18x15: 4x4, 5x5, 8x5, 8x8, 12x9, 16x11, 18x15 cm 16x9: 4x4, 5x5, 8x5, 8x8, 12x9, 16x9 cm	
Voxel Size	4x4	0.05 mm
	5x5	0.08 mm / 0.12 mm
	8x5 / 8x8	0.12 mm / 0.2 mm
	12x9 / 16x9 / 16x11 / 18x15	0.2 mm / 0.3 mm
Scan Time	Pano	4.0 sec / 14.1 sec
	Ceph	1.9 sec / 4.9 sec
	CBCT	2.9 sec (5x5 - 8x8) / 9.0 sec (12x9 - 18x15) / 18.0 sec (4x4)
Gray Scale	14 Bit	
Tube Voltage / Current	60 - 99 kVp / 4 - 16 mA	
Weight	Without CEPH unit	365.74 lbs - without Base
		487.00 lbs - with Base
	With CEPH unit	420.86 lbs - without Base
		542.11 lbs - with Base
Dimensions	With CEPH unit	75.019" (L) x 54.129" (W) x 91.157" (H) - without Base
		75.019" (L) x 54.129" (W) x 92.338" (H) - with Base
	Without CEPH unit	42.716" (L) x 52.893" (W) x 91.157" (H) - without Base
		42.716" (L) x 52.893" (W) x 92.338" (H) - with Base

*The specifications are subject to change without prior notice.

DIMENSIONS [Unit: Inch]

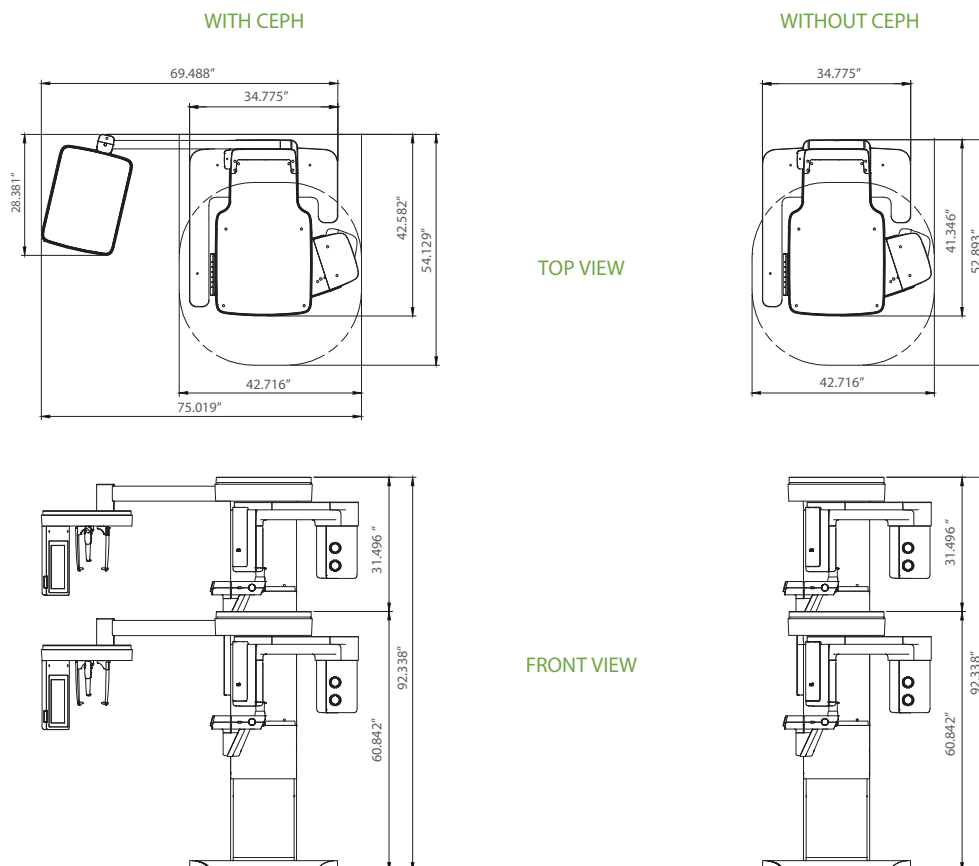

***An additional 3 inches (76.2 mm) of space is required behind the unit for wall mount bracket installation (mandatory unless there is a base mount installation).**

SPEED, QUALITY, PREDICTABILITY NO COMPROMISE

Green X Plus™



- ONE SCAN, TWO IMAGES
- MULTI FOV SELECTION
- ENDO MODE WITH HIGH RESOLUTION
- 3D SCANNING FOR MODEL



ONE SCAN, TWO IMAGES

One scan with the Green X Plus gives you a CT image and Auto Pano image. This means that patients who require both images do not need to undergo two x-ray scans. The CT and Auto Pano images are displayed within One Viewer as well.



* Conventional panorama mode is provided.

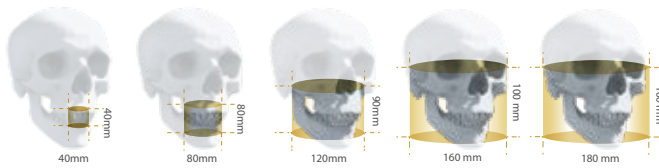

MULTI FOV SELECTION

The Green X Plus offers a range of selectable fields of view. The Multi FOV option allows users to select the optimum FOV mode while minimizing exposure to areas that are not in the region of interest. The selection includes the following FOV sizes for diagnostic needs: 18x10, 16x10, 12x9, 12x5, 8x8, 8x5, 5x5, and 4x4. These options cover the full arch region, sinus and left/right TMJ, and suits most oral surgery cases and multiple implant surgeries.

	FOV 4x4 / 5x5	FOV 8x5 / 8x8	FOV 12x9	FOV 16x10	FOV 18x10
REGION	- Single tooth capture	- Dual arch	- Dual arch including sinus and nerve	- Back border of jaw (Ramus) - Dual arches back to the 3rd molar plus sinus - Central incisor to spine	- Complete arch - TMJ
CLINICAL IMPLICATION	- Implant single site - Endo Diagnosis - Perio - Complex Impaction (3rd) - OMS - Supernumerary; Ortho	- Implant planning - Bone grafting - Endo Diagnosis - Impactions - Root fractures	- Surgical guides - Sinus lifts - Bone grafting - Bi lateral sinus augmentation	- Surgical guides - Sinus lifts for both sinuses - Complex orthognathic cases	- General dentist - OMS - Orthodontics

ENDO MODE WITH HIGH RESOLUTION

With its 4cm x 4cm volume mode and 50 micron voxel size, the endo mode will optimize treatment of highly-focused regions of interest. It is ideal for endodontic use because the dentist is able to achieve an extraordinary image in a high-resolution voxel size.

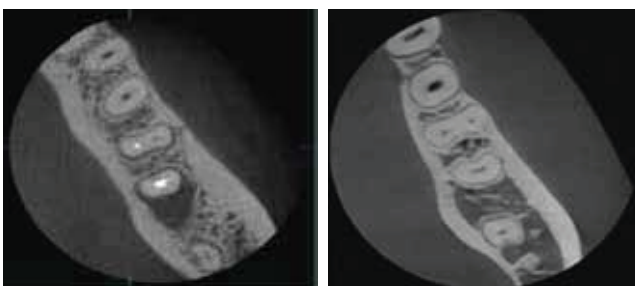

Dental Mode vs. Endo Mode

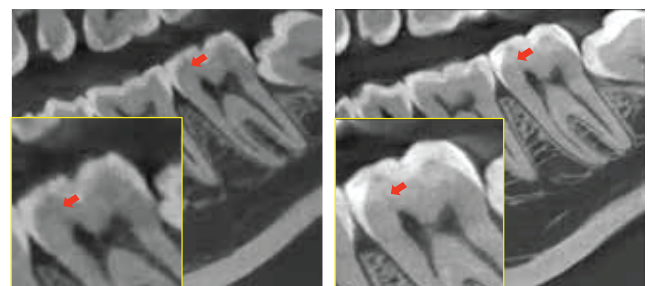

Dental Mode vs. Endo Mode

3D SCANNING FOR MODEL

3D model scan enables users to store plasters as digital models. The specially designed Jig offers stable protection from partial model to full model.



*3D scanning for Plaster Cast with FOV 8x8 (cm)

SPECIFICATIONS [Green X Plus : **PHT-70CHS**]

Function	CT + Pano + Ceph + Model Scan	
Focal Spot Size	0.5 mm (IEC 60336)	
CT FOV Size	4x4, 5x5, 8x5, 8x8, 12x5, 12x9, 16x10, 18x10 cm	
Voxel Size	4x4	0.05 mm
	5x5	0.08 mm
	8x5 / 8x8	0.12 mm
	12x5 / 12x9	0.12 mm / 0.2mm
	16x10	0.3 mm
	18x10	0.2 mm
Scan Time	Pano	4.0 sec / 14.1 sec
	Ceph	1.9 sec / 4.9 sec
	CBCT	7.0 sec (5x5-8x8) / 15.2 sec (12x5, 12x9, 16x10, 18x10) / 18.0 sec (Endo 4x4)
Gray Scale	Pano, CBCT	14 Bit
	Ceph	16 Bit
Tube Voltage / Current	60 - 99 kVp / 4 - 16 mA	
Weight	Without CEPH unit	320.1lbs - without Base
		437.0 lbs - with Base
	With CEPH unit	375.2 lbs - without Base
		492.1 lbs - with Base
Dimensions	With CEPH unit	75.7" (L) x 53.07" (W) x 91.5" (H) - without Base
		75.7" (L) x 53.07" (W) x 92.8"(H) - with Base
	Without CEPH unit	44.5" (L) x 53.07" (W) x 91.5" (H) - without Base
		44.5" (L) x 53.07" (W) x 92.8" (H) - with Base

*The specifications are subject to change without prior notice.

DIMENSIONS [Unit: Inch]

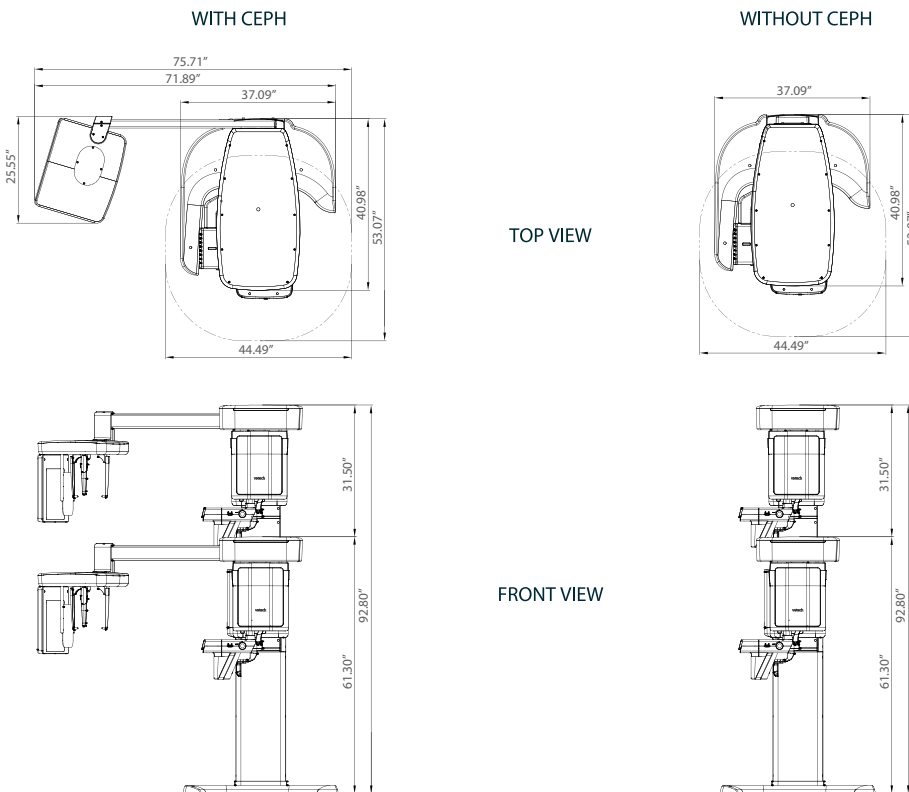

***An additional 3 inches (76.2 mm) of space is required behind the unit for wall mount bracket installation (mandatory unless there is a base mount installation).**

SPEED, QUALITY, PREDICTABILITY
NO COMPROMISE

Green X 21™

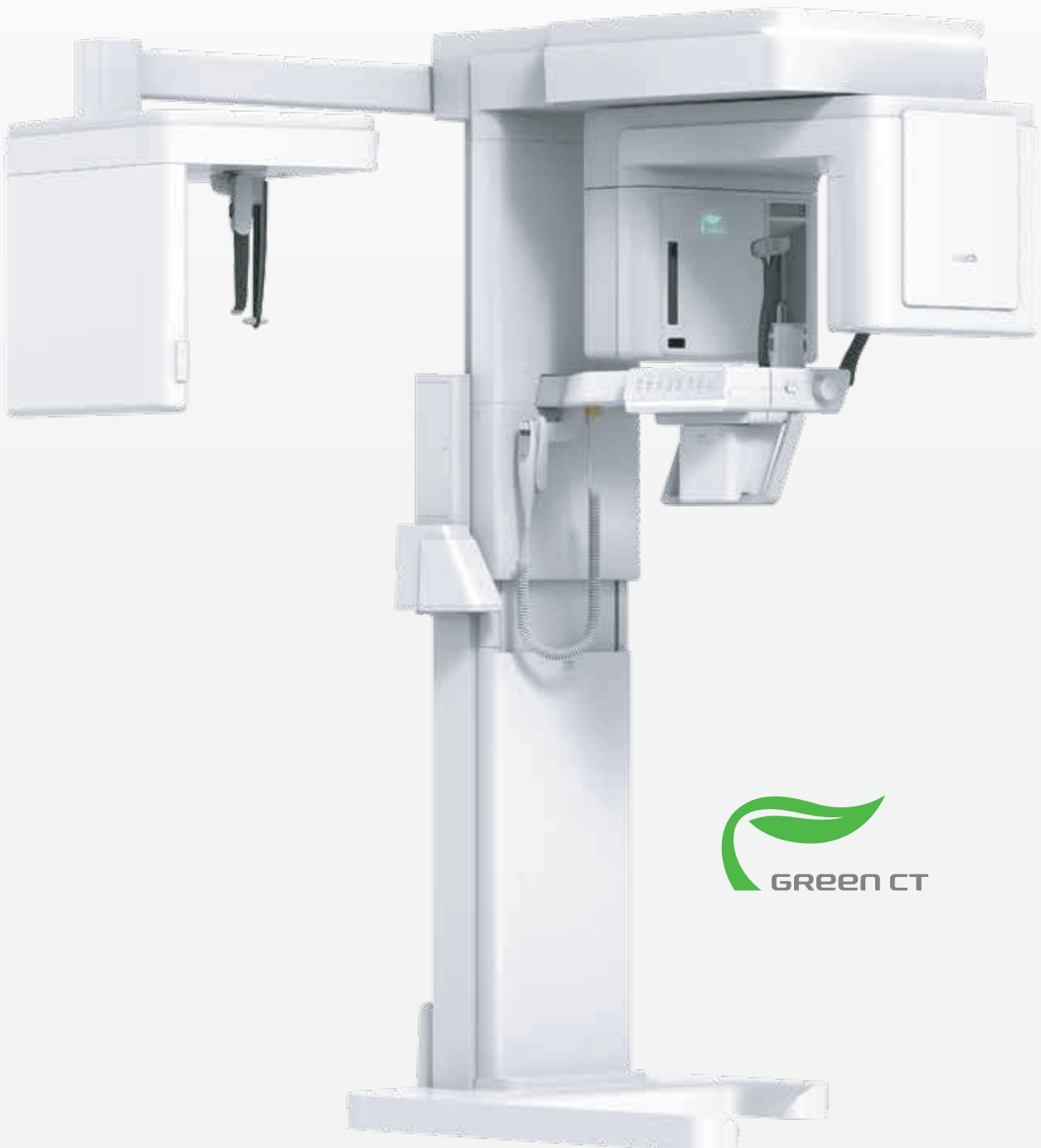



ENDO MODE WITH HIGH RESOLUTION

With the endo mode will optimize treatment of highly-focused regions of interest. It is ideal for endodontic use because the dentist is able to achieve an extraordinary image in a high-resolution voxel size.



Dental Mode vs. Endo Mode

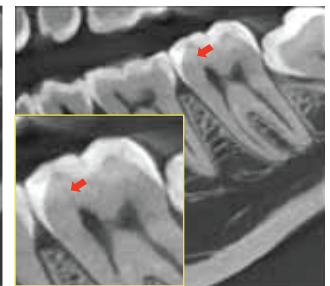
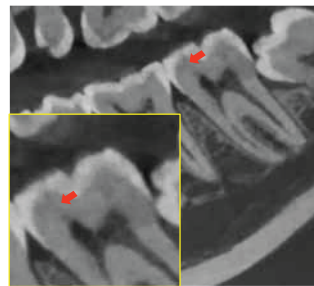

Dental Mode vs. Endo Mode

MULTI FOV SELECTION

The Green X 21 offers a range of selectable fields of view. The Multi FOV option allows users to select the optimum FOV mode while minimizing exposure to areas that are not in the region of interest. The selection includes the following FOV sizes for diagnostic needs: 21x19, 18x15, 12x9, 12x5, 8x8, 8x5, 5x5 and 4x4. These options cover the full arch region, sinus and left/right TMJ, and suits most oral surgery cases and multiple implant surgeries.

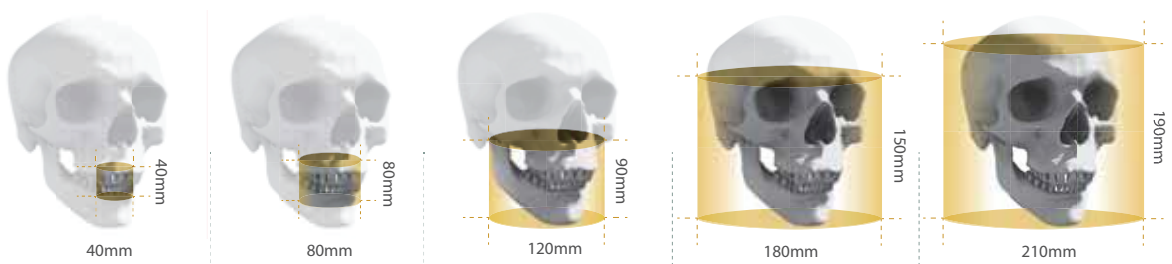

	FOV 4x4/5x5	FOV 8x5/8x8	FOV 12x5/12x9	FOV 18x15	FOV 21x19
REGION	- Single tooth capture	- Central dentition - TMJ (R or L)	- Dual arch including sinus and nerve - TMJ (R or L)	- Back border of jaw (Ramus) - Dual arches back to the 3 rd molars plus sinus - Central incisor to spine	- Nearly entire cranium - Tip of nose to posterior of cranium - C5, C6 to superior sinus
CLINICAL IMPLICATION	- Implant single site - Endo - Perio - Complex impaction (3rd) - OMS - Supernumerary : Ortho	- Implantology - Guided Surgery - General Dentist - OMS - Orthodontics	- Surgical guides - Sinus lifts - Bone grafting - Bi lateral sinus augmentation	- Surgical Guides - Sinus lifts for both sinuses - Complex orthognathic cases - Simultaneous diagnosis for both TMJs	- Airway - Oral and maxillofacial surgery facial reconstructions - Orthodontic treatment planning for complex orthognathic cases



ONE SCAN, THREE IMAGES

One scan with the Green X 21 gives you a CT, Auto Pano and Auto Ceph image. This means that patients who require all images do not need to undergo three x-ray scans.



MINIMIZE MOTION ARTIFACTS WITH ONE SHOT TECHNOLOGY

The next step in cephalometric technology, Vatech's new One Shot minimizes motion artifacts and enables faster diagnostic workflow while providing the highest quality digital images.

GREAT CLINICAL CARE WITH ONE SHOT TECHNOLOGY



0.9
sec

SPECIFICATIONS [Green X 21 : PHT-90CHO]

Function	CT + Pano + Ceph + Face Scan + Model Scan	
Focal Spot Size	0.5 mm (IEC 60336)	
CT FOV Size	4x4, 5x5, 8x5, 8x8, 12x5, 12x9, 18x15, 21x19 cm	
Face Scan FOV Size	12x9, 18x15, 21x19 cm	
Voxel Size	4x4	0.05 mm
	5x5	0.08 mm / 0.12 mm
	8x5 / 8x8	0.12 mm / 0.2 mm
	12x5 / 12x9 / 18x15 / 21x19	0.2 mm / 0.3 mm
Scan Time	Pano	4.0 sec / 14.1 sec
	Ceph	0.9 sec
	CBCT	7.0 sec (5x5 - 12x9) / 15.2 sec (18x15, 21x19) / 18.0 sec (Endo 4x4)
Gray Scale	16 Bit	
Tube Voltage / Current	60 - 99 kVp / 4 - 16 mA	
Weight	Without CEPH unit	364.64 lbs - without Base
		486.56 lbs - with Base
Weight	With CEPH unit	418.88 lbs - without Base
		540.79 lbs - with Base
Dimensions	With CEPH unit	75.29" (L) x 52.89" (W) x 91.24" (H) - without Base
		75.29" (L) x 52.89" (W) x 92.34" (H) - with Base
	Without CEPH unit	42.72" (L) x 52.89" (W) x 91.24" (H) - without Base
		42.72" (L) x 52.89" (W) x 92.34" (H) - with Base

*The specifications are subject to change without prior notice.

DIMENSIONS [Unit: Inch]

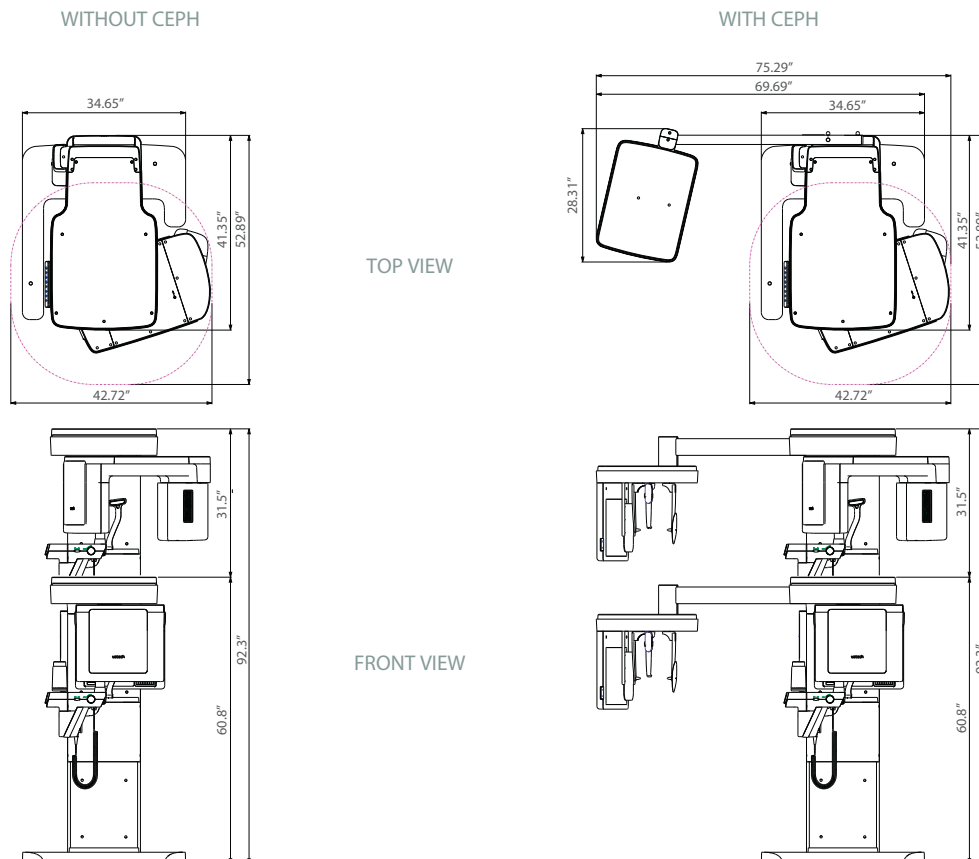

*An additional 3 inches (76.2 mm) of space is required behind the unit for wall mount bracket installation (mandatory unless there is a base mount installation).

Clever One

ALL IN ONE SMART VIEW, SUPPORTING YOUR CARE

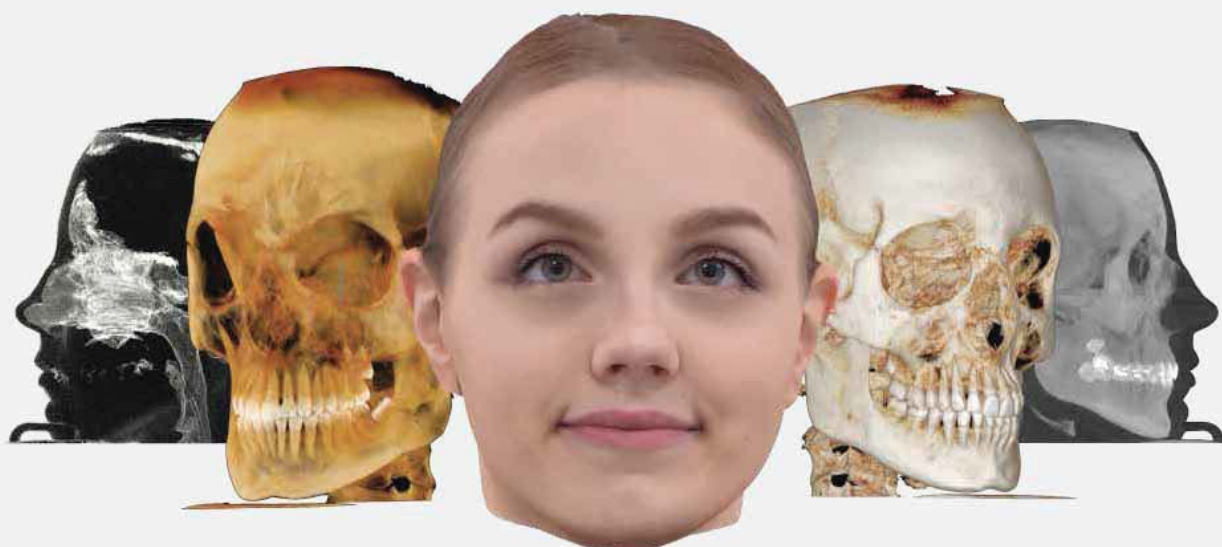

ALL YOUR IMAGES, ONE UNIFIED VIEW

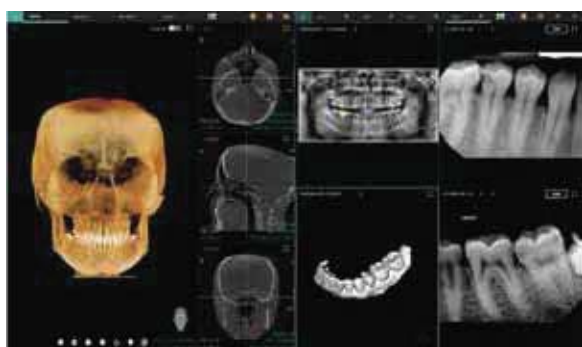

No more switching between platforms or dealing with file compatibility issues. Clever One seamlessly integrates panoramic images, CT scans, 3D photos, and intraoral scans together in a single viewer. Its intelligent layout keeps everything organized and in focus, helping you work more efficiently and make better clinical decisions faster.

TOTAL DATA INTEGRATION FOR A COMPLETE PATIENT OVERVIEW



Clever One brings together diverse patient data, from facial scans and CTs to intraoral images, into one synchronized view. This unified display helps clinicians manage and understand patient information more effectively, supporting consistent communication and greater clinical precision. Now you can forget the struggle of switching between screens and simply enjoy one clear, comprehensive view.

DIAGNOSTIC ASSIST WITH AI PATHOLOGY DETECTION

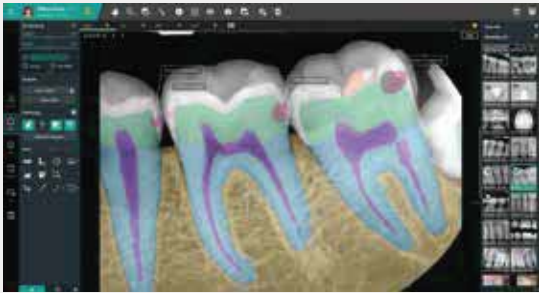

Smarter Diagnosis, AI-Powered Support

Clever One integrates Pearl AI's pathology detection engine to clearly highlight findings within patient images. This is not a replacement for your expertise. It is an intelligent tool designed to enhance it. By marking areas of concern, it helps you make confident, informed decisions quickly and efficiently, all while staying seamlessly aligned with your workflow.

ANIMATED EDUCATIONAL VIDEOS FOR PATIENT ENGAGEMENT



Educate and Empower with Over 260 Animated Videos Made Your Way

Premium visuals bridge the gap between clinical language and patient understanding. With more than 260 animated videos covering a wide range of dental treatments, patients can better visualize diagnoses and procedures. You can also create personalized playlists by treatment category to make consultations more efficient, organized, and professional.

DUAL MONITOR SUPPORT FOR EASY SIDE BY SIDE COMPARISON



Compare with Confidence Using Before and After Views

Clever One supports dual monitor setups so you can view pre-and post-treatment images side by side. With Pearl AI's pathology detection built in, you can review images with AI-marked findings for faster, more precise decision-making. It's all about enhancing clarity while keeping your workflow seamless.

EFFECTIVE SIMULATION MAKES COMMUNICATION CLEARER



Turn Complexity into Clarity with Visual Simulations

Easily simulate treatment scenarios such as implant placement, nerve tracing, or sinus drawing using intuitive tools. Displaying these visual elements directly on the patient's image transforms technical explanations into something easy to understand. Whether you're planning treatment or educating a patient, simulations make every conversation clearer and more impactful.

CLOUD-POWERED FREEDOM TO WORK ANYTIME, ANYWHERE



Smarter Data Management with EzCloud Integration

Clever One integrates seamlessly with EzCloud, allowing you to securely store and access patient images, simulations, and consultation materials from anywhere. Whether you're in the clinic, attending a seminar, or on the go, everything is available at your fingertips. Collaborate in real time by leaving comments, reviewing updates, and refining treatment plans. Leave USB and email chains behind to embrace a more efficient, secure, and easy way of sharing.

WORK YOUR WAY WITH AN INTERFACE THAT ADAPTS TO YOU



Customize Your Workflow

Clever One features a fully flexible UI/UX layout, allowing clinicians to personalize panels and tools based on their preferences. Whether you're left- or right-handed, or working with a single monitor, you can tailor the interface to suit your style. This makes your workflow more efficient, intuitive, and truly yours.

Ez3D-i

CUTTING-EDGE SOFTWARE FOR CUTTING-EDGE DIAGNOSTICS

Powered by a new 3D VR graphics engine, Ez3D-i is the ideal tool to quickly and easily obtain the correct perspectives needed for accurate, true-to-measurement diagnosis.

Quick and Easy **Dental 3D Imaging Software** for Every Dentist

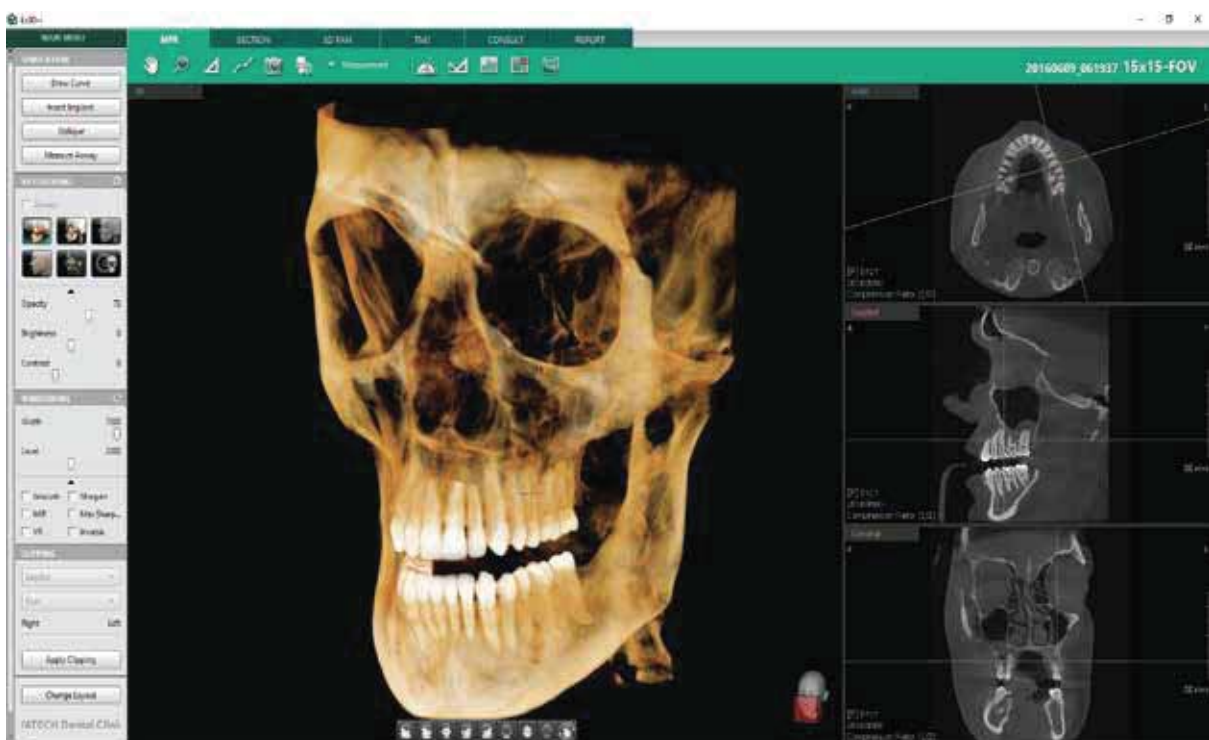

PROVIDES QUICK AND ACCURATE DIAGNOSTIC TOOLS

- Various VR Coloring Modes and 2D Filters
- Intuitive Implant Simulation Tools
 - Collision Detection (Implant/Canal)
 - Bone Density Verification
 - Oblique Viewing Tools
- 3D Panoramic Navigation
- 2-Click Airway Analysis
- Multiple Sectional Curves and Segmentation Tools

CONSULTATION MODES INCLUDED

- Presentation Mode
- Over 200 Consultation Videos
- Easy to Capture Diagnostic Image
- 3D Panorama



Supports Various VR Coloring modes

- Teeth Mode
- Bone Mode
- Soft-Tissue Bone Mode
- MIP Mode
- Soft-Tissue Mode



Virtual Consultation Tool

- Over 200 Consultation Videos
- Creation of Personalized Consultation Materials



Implant Simulation

- 3 Click Implant Simulation
- Collision Detection
- Bone Density
- 3D Panorama
- Oblique View Mode



Provides Quick and Accurate Cross-Section

- 8 Multi-Section(Curve) Management
- One-Click Cross Section (3D PAN tab)
- Canal Drawing

VARIOUS VR COLORING MODES AND 2D FILTERS

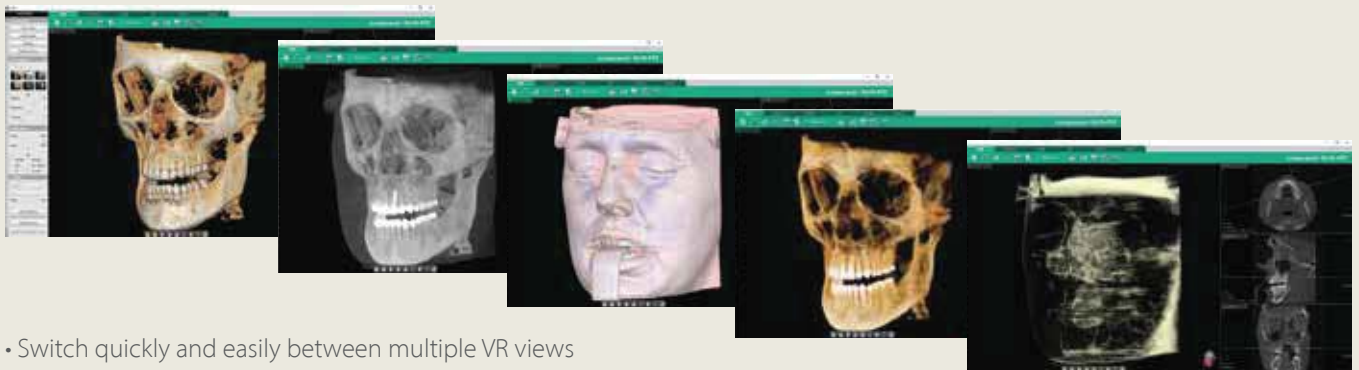

- Switch quickly and easily between multiple VR views

2-CLICK AIRWAY ANALYSIS



- With two clicks, obtain the volume and minimum axial area of an airway for efficient airway diagnosis

FEATURING VATECH'S VIRTUAL CONSULTATION TOOL



- With over 200 unique animations, the virtual consultation tool gives you the tools to not only educate patients on treatment plans, but also to show how the plan is relevant to their specific case

3D PANORAMIC NAVIGATION



By clicking 3D Navigator and positioning to ROI, it's easy to verify 2D sectional images

- Easily navigate and obtain a sectional view by utilizing our new and intuitive 3D panoramic navigation mode
- Simply click and drag our viewing window over the 3D panorama to obtain a sectional view of that region
- Angulation made easy

IMPLANT SIMULATION

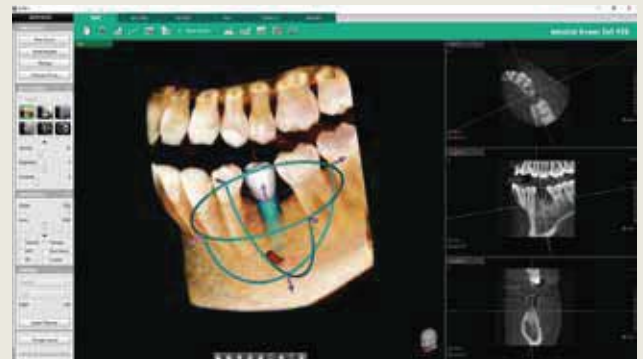

MPR tab

- Available in all viewing modes in Ez3D-i (MPR/Section/3DPan)
- Colorized bone density viewing modes available
- Adjustable automatic implant collision detection function between multiple implants and/or nerve canal

THE WORLD'S FIRST CLINICAL IMAGING & PATIENT CONSULTATION SOLUTION



Featuring... Vatech's Virtual Consultation Tool (VCT)

With over 200 unique animations, the virtual consultation tool gives you the tools to not only educate patients on treatment plans, but also to show how the plan is relevant to their specific case.



Get The Most Out Of Your Images

Using our revamped Sharpening and Max Sharpening tools, enhance the quality of your images even further than ever before.



Manage Your Images, The Easy Way

Organize and export your images quickly and efficiently and avoid complicated procedures and training using EzDent-i's intuitive Click-And-Drag based interface.





EzRay Air™ Wall

WEIGHT INNOVATION

WALL-MOUNTED INTRAORAL X-RAY



Round Shape Design

Stable Arm

One-Handed Grip

WEIGHT INNOVATION WITH CNT (CARBON NANO TECHNOLOGY)

The wall mounted EzRay Air Wall is a lightweight x-ray device designed for easy handling and stable positioning for optimal image quality on your intraoral x-rays.

The EzRay Air Wall's lightweight tube head provides users with a stable and easy to use x-ray source which maximizes image clarity and optimizes workflow.



SMART DIAL FOR ALL FUNCTIONS

The operating panel located on the tube head creates a much simpler and much faster workflow. Using the smart dial, practitioners will notice a decrease in preparation time and less of a need to remember complicated control buttons and configurations.

SECURE CLEAR IMAGES WITH A 0.4MM FOCAL SPOT

Compared to other intraoral x-rays on the market, the EzRay Air Wall provides optimal image quality and additional diagnostic value with a 0.4mm focal spot.



* Exposure Condition : 65kV, 3.0m A



SPECIFICATIONS [EzRay Air Wall : VEX-S300W]

Focal Spot	0.4 mm (IEC 60336)
Tube Voltage	65 kV
Tube Current	3.0 mA
Exposure Time Range	0.05 ~ 0.5 (0.01s increment)
Source to Skin Distance	Min. 7.9 inch
X-ray Field	Default: : 60 mm Round, 30x40 mm Rectangular / Optional: 20x30 mm Rectangular
Arm Length [Option]	62"/ 68"/ 80" *See note A
Accessories	Remote Exposure Switch (Hand Switch / Doorbell Switch)
Weight	56.9 lb (Arm Length 62")
	58.0 lb (Arm Length 68")
	61.1 lb (Arm Length 80")

* The specifications are subject to change without prior notice.

DIMENSIONS [Unit: inch]

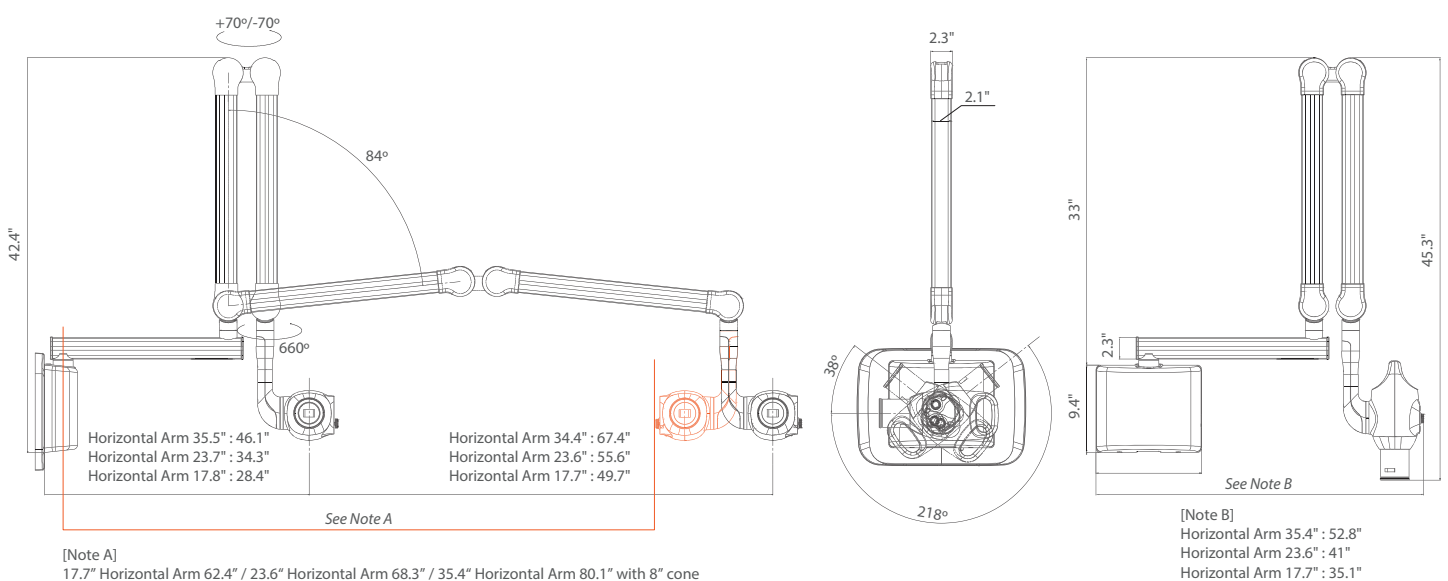



EzRay AirTM Portable

WEIGHT INNOVATION

WORLD'S FIRST CNT (CARBON NANO TECHNOLOGY) PORTABLE X-RAY

FASTER WORKFLOW



WEIGHT INNOVATION WITH CNT (CARBON NANO TECHNOLOGY)

The world's first dental application of Carbon Nano Technology.

The EzRay Air Portable is a lightweight portable x-ray device that is designed for easy handling and stable positioning, delivering optimal image quality for your intra-oral x-ray images.

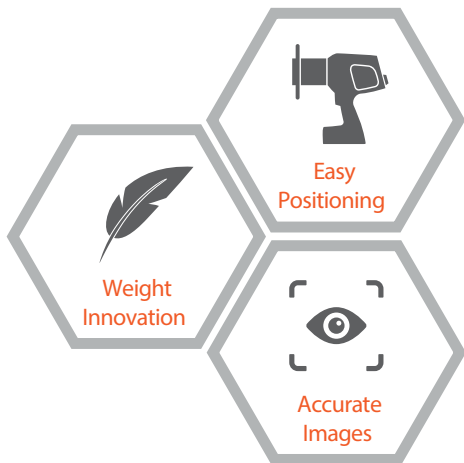

DOUBLE SCATTER SHIELD DESIGN FOR OPERATOR SAFETY

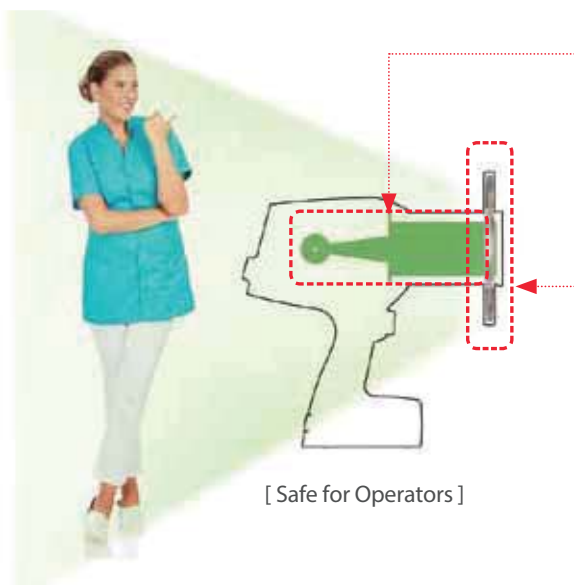

INTERNAL SHIELDING

The internal radiation shielding is perfectly designed to protect the operator from radiation leakage.

EXTERNAL BACKSCATTER SHIELDING

Exposure to radiation results from the beam interacting with the surface of the patient, causing radiation to bounce off as radiation scatters in different directions. The backscatter shield significantly reduces the amount of radiation being reflected.

NO WARMUP TIME

With no initial start-up delay for conventional x-ray sources to warm up, the EzRay Air Portable's Carbon Nano Technology optimizes workflow by allowing for quicker exposure after you initially turn on the device.





SPECIFICATIONS [EzRay Air Portable: VEX-P300]

Focal Spot	0.4 mm (IEC 60336)
Tube Voltage (kV)	65 kV
Tube Current (mA)	2.5 mA
Exposure Time	0.05 ~ 1.0 sec
Total Filtration	Min. 1.5 mm Al
Source to Skin Distance	200 mm
X-ray Field	Default: 60 mm Round, 30 x 40 mm Rectangular / Optional: 20 x 30 mm Rectangular
Maximum Duty Cycle	1 : 60
Power Input	21.6 V
Weight	4.7 lbs. (2.1 kg)

* The specifications are subject to change without prior notice.

DIMENSIONS [Unit: Inch]

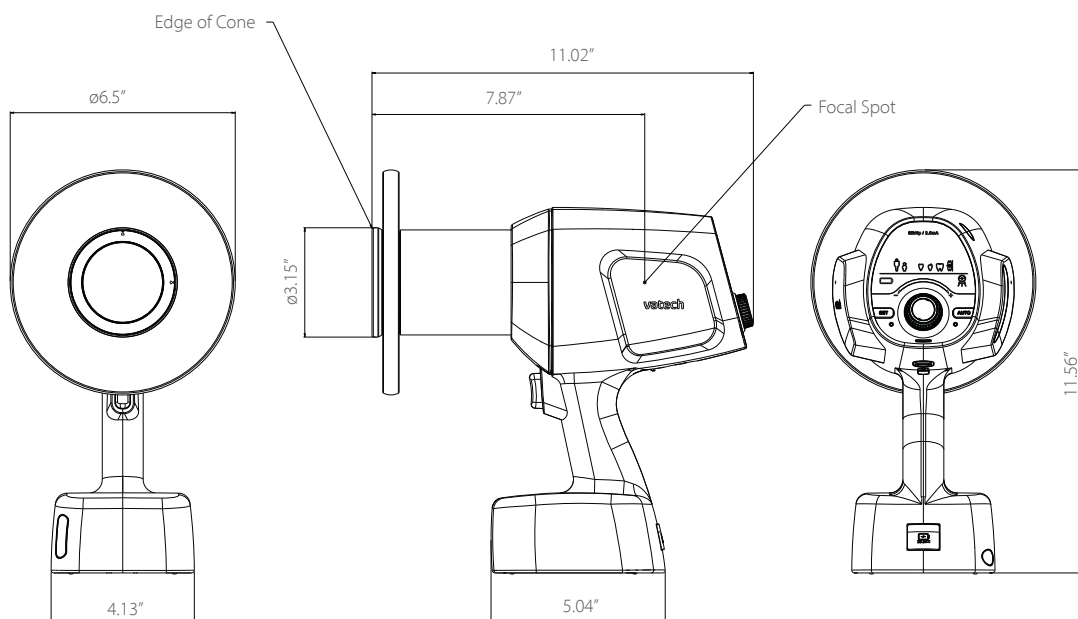

REDEFINING INTRAORAL SENSORS

HD Sensor



-  EXPERIENCE THE HIGHEST RESOLUTION
-  4.8 MM ULTRA-SLIM DESIGN
-  NEW CONTRAST FILTERS FOR YOUR PERFECT IMAGE



HD EXPERIENCE THE HIGHEST RESOLUTION

The HD Sensor is clinically usable at a wide range of exposure settings and is more consistent than all of the other sensors in the market. Practitioners benefit from reducing exposure-related retakes and find it less time consuming. Also, patients benefit from the reduction of radiation exposure. With our high sensitivity sensor, you can capture diagnosable images under any condition, even when using an old x-ray source.

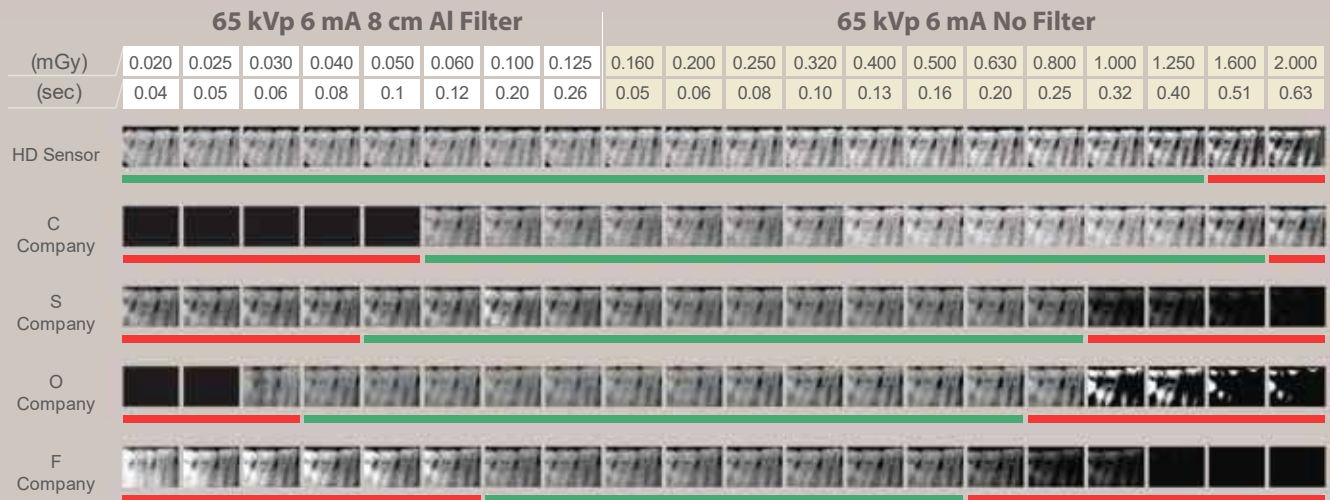

NEW CONTRAST FILTERS FOR YOUR PERFECT IMAGE

Switch quickly and easily among seven new contrast filters to find your perfect diagnostic image. Higher contrast filters can be utilized for periodontics, while lower contrast filters can be used for caries detection and restorative dentistry.

With the HD Sensor, you will always have these filters at your disposal.

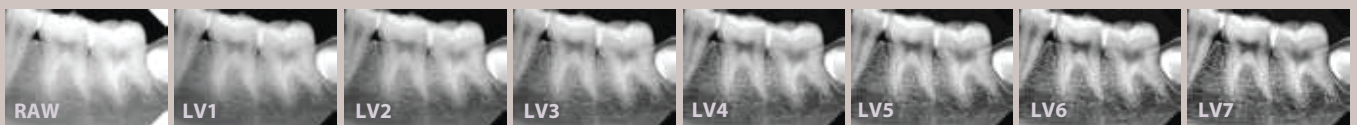
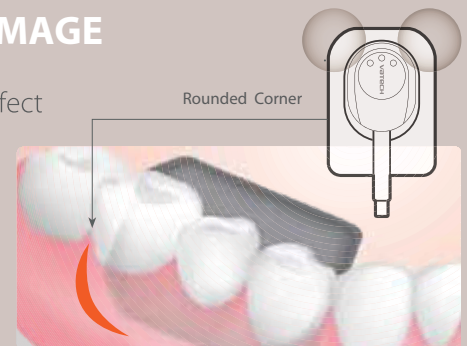

SPECIFICATIONS (HD Sensor : IOS-U10IF / IOS-U15IF / IOS-U20IF / IOS-U10VF / IOS-U15VF / IOS-U20VF)

Detector	CMOS	Pixel Size	14.8 μm
Theoretical Resolution	33.78 lp/mm	Dynamic Range	12 bit
Active Area (WxL)	Size 1.0 : 0.79" x 1.18" Size 1.5 : 0.94" x 1.30" Size 2.0 : 1.02" x 1.42"	Dimensions (WxLxT)	Size 1.0 : 1.00" x 1.45" Size 1.5 : 1.14" x 1.55" Size 2.0 : 1.23" x 1.69"
Thickness	0.19"	Cable Length	2.7 m

* The specifications are subject to change without prior notice.

[Intended use]

An HD Sensor is intended to collect dental x-ray photons and convert them into electronic impulses that may be stored, viewed, and manipulated for diagnostic use by dentists.

EzCam

USB INTRAORAL CAMERA



A LIGHTWEIGHT CAMERA INTELLIGENTLY DESIGNED FOR EASE OF USE

- Real auto focus intraoral camera.
- Automatic device power control when viewing software is turned on.
- Equipped with an aspheric lens that eliminates distortion and provides a more uniform image quality.
- Provides more detailed images with designs to minimize the light reflection of the tooth surface.
- Two easy-to-use capture buttons.
- Auto-installation of capture program when device is plugged into laptop.



"High definition image without distortion"

SPECIFICATIONS

Image sensor:	CMOS / 5 Mega pixel	Length of cable:	USB2.0 / 3m
Resolution:	1280 x 720	Dimensions:	0.94" (w) x 0.91" (d) x 7.80" (h)
Light source:	2 White LEDs	Weight:	39.5g (0.087 lbs)
Focus range:	9mm~35mm (Auto focus)	Operating Voltage:	DC5V/ 500mA
Angle of view:	62°		



vatech

Vatech America, Inc. | Tel: (201) 210-5118 | sales@vatechamerica.com | 06/2026

www.vatechamerica.com